

JGC0358

Page 1 of 5

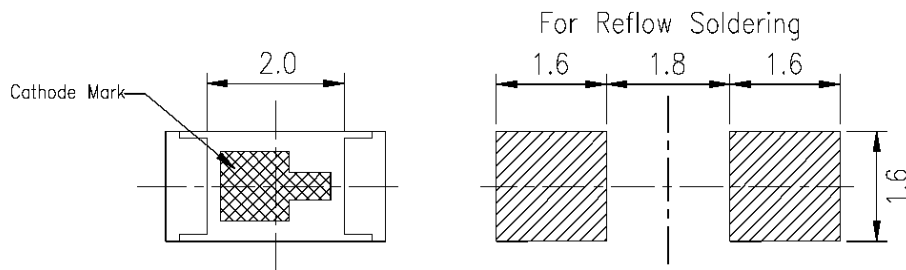

RoHS Compliant
Aug 2004

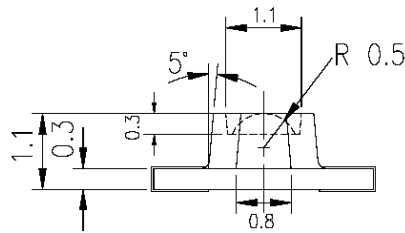
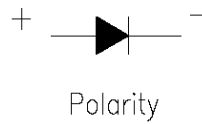
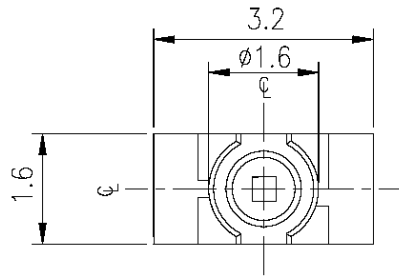

PART NO.	Chip		Lens Color
	Material	Emitted Color	
JGC0358	AlGaInP	Green	Water Clear

* Specifications subject to change without notice. Dimensions are in mm ± 0.1 unless stated otherwise.



Absolute Maximum Ratings at T_a = 25 °C

Parameter	Symbol	Rating	Units
Forward Current	I _F	25	mA
Reverse Voltage	V _R	5	V
Operating Temperature	T _{opr}	-40 to +85	°C
Storage Temperature	T _{stg}	-40 to +90	°C
Electrostatic Discharge	ESD	2000	V
Power Dissipation	P _d	60	mW
Peak Forward Current (Duty 1/10 @ 1KHz)	I _{FP}	160	mA
Soldering Temperature	T _{sol}	Reflow Soldering: 260°C for 10 sec. Hand Soldering: 350°C for 3 sec.	

Electronic Optical Characteristics (T_a = 25 °C)

Parameter	Symbol	Min.	Typ.	Max.	Units	Condition
Luminous Intensity	I _V	18	24	—	mcd	I _F = 20 mA
Viewing Angle	2θ _{1/2}	—	60	—	deg	
Peak Wavelength	λ _p	—	575	—	nm	
Dominant Wavelength	λ _d	—	573	—	nm	
Spectrum Radiation Bandwidth	Δλ	—	20	—	nm	
Forward Voltage	V _F	1.7	2.0	2.4	V	
Reverse Current	I _R	—	—	10	μA	V _R = 5 V

* Specifications subject to change without notice. Dimensions are in mm ±0.1 unless stated otherwise.

Typical Electro-Optical Characteristics Curves:

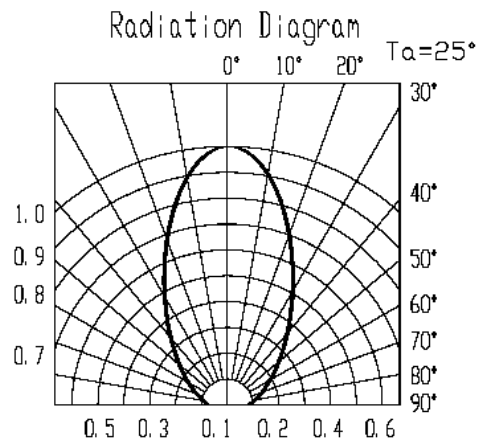
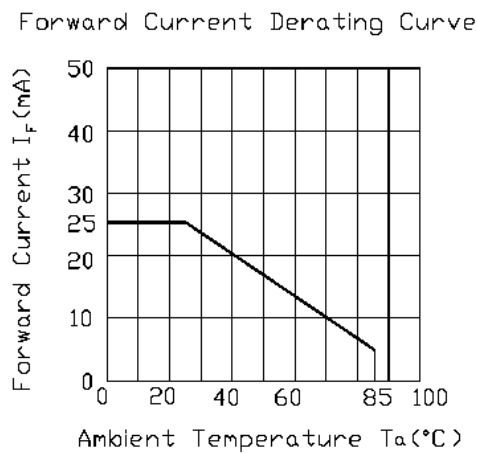
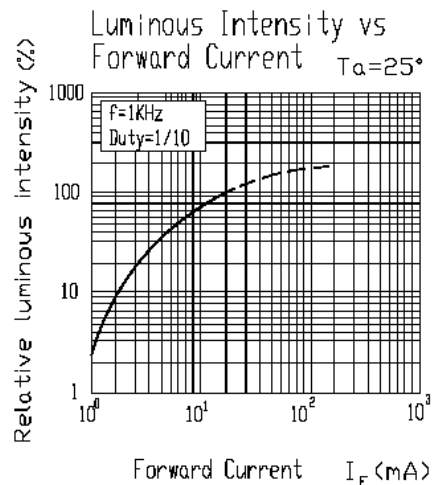
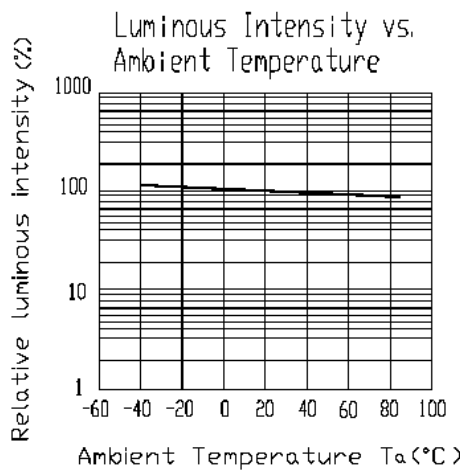
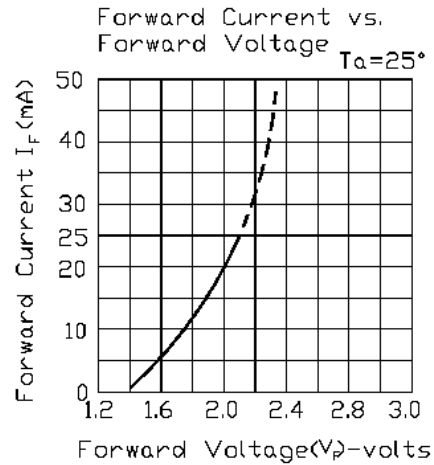
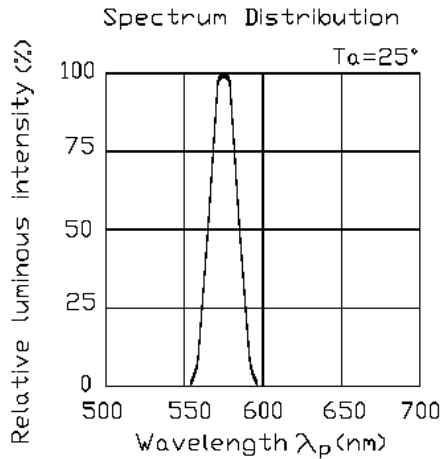

* Specifications subject to change without notice. Dimensions are in mm ± 0.1 unless stated otherwise.

JGC0358

Page 4 of 5



Reel Dimensions:

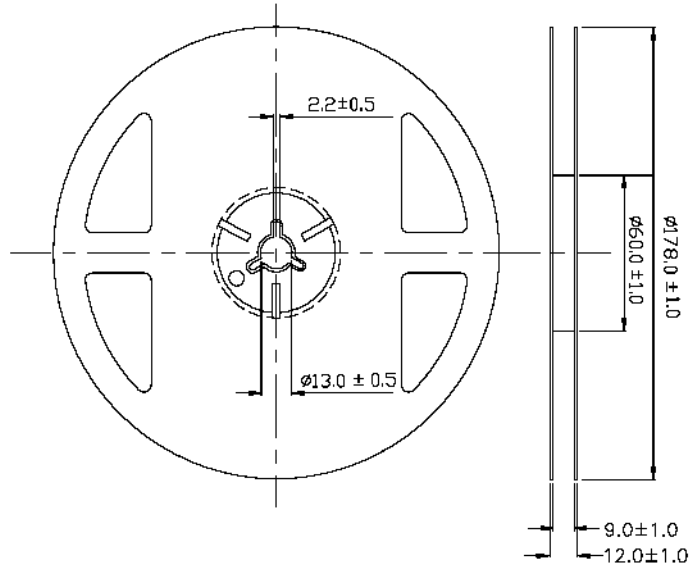

Carrier Tape Dimensions:

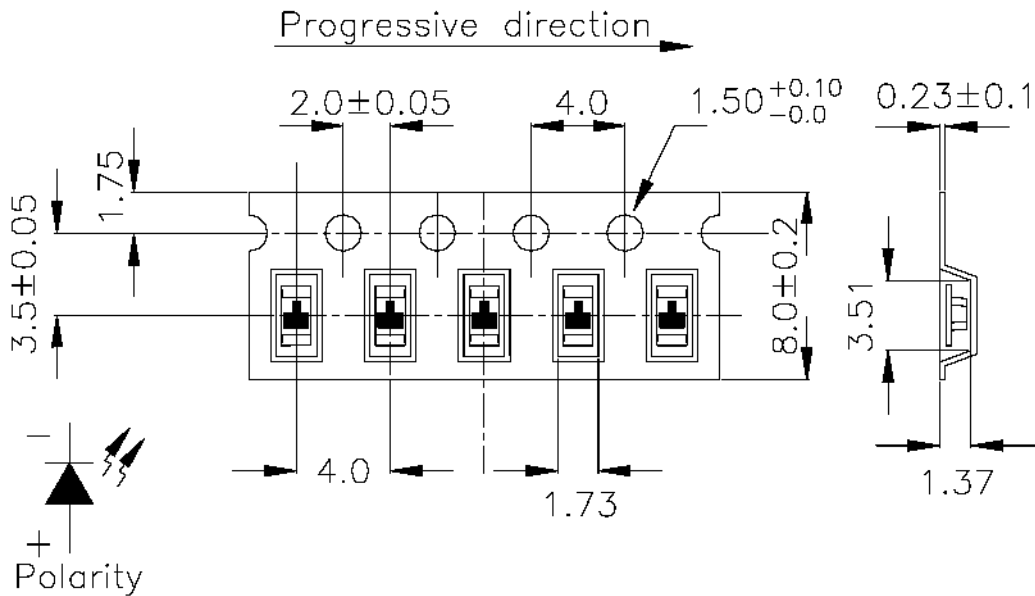

* Specifications subject to change without notice. Dimensions are in mm ± 0.1 unless stated otherwise.

Precautions for Use

1. Over-current prevention:
A series resistor must be used for protection against over-current. Since slight voltage shifts can cause large current changes and possibly damage the LED.
2. Storage:
 - 2.1. Store the LEDs in the sealed moisture proof bag until ready to use.
 - 2.2. The storage conditions should be below 30°C and 90% RH or less.
 - 2.3. Unused portions of LEDs may be stored in moisture proof packages for up to 1 year if kept under 30°C and at no more than 60% RH.
 - 2.4. If there is evidence of moisture absorption or if the LEDs have been stored for a long time, bake the LEDs at 60°C ± 5°C for 24 hours prior to using.
3. Reflow Soldering Conditions:
 - 3.1. Pb-free solder temperature profile (see figure):

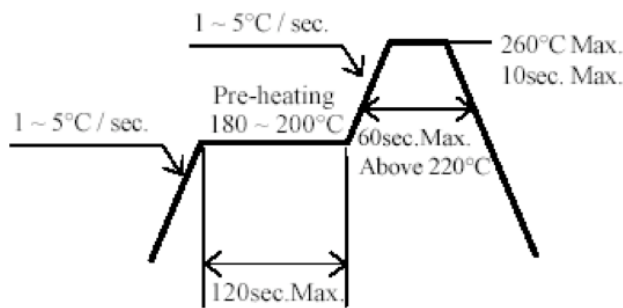

- 3.2. Reflow solder no more than two times and must include time interval for the board to cool.
- 3.3. When soldering, do not put stress on the LEDs during heating.
- 3.4. After soldering, do not warp the circuit board.
4. Hand Soldering:
Use a low wattage soldering iron (below 25 watts) with a tip temperature no more than 350°C for 3 sec or less on one terminal. Wait at least two seconds before soldering the next terminal to avoid overheating the LED and damaging it.
5. Avoid reworking a soldered LED. It is best to simply replace it with a new part.

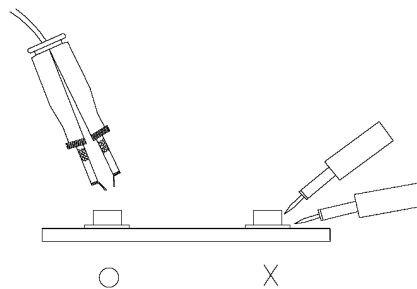

* Specifications subject to change without notice. Dimensions are in mm ±0.1 unless stated otherwise.